



TECHNICAL SERVICE PARTS

STYLE 4802

PRODUCT 1" ASSAULT NOZZLE

IF AN ITEM IS NOTED AS "NOT FIELD REPAIRABLE", OR YOU WISH TO RETURN AN ITEM TO AKRON BRASS FOR SERVICE PLEASE GO ONLINE TO, ONLINEREPAIR.AKRONBRASS.COM

Chg.	Date
03	06-19
04	03-20

ASSEMBLY NOTES:

USE PARKER O-LUBE ON ALL O-RINGS AND ALL MATING SURFACES.

- 1 USE LOCTITE 222 OR 113 PERMABOND.
- 3 DIMPLE AT ASSEMBLY.
- 4 DO NOT CUT TURBINE TEETH.
- 8 TIGHTEN SCREW.
- 9 RAISED LUG INLINE WITH NARROW FOG FOR EN NOZZLES. ALL OTHERS INLINE WITH STRAIGHT STREAM.
- 10 APPLY LOW-TEMP LUBRIPLATE IN CAM INSERT SLOT WHEN DETENT IS SPECIFIED.
- 12 AS SPECIFIED.
- 13 ASSEMBLE DETENT SPRING AND BALL IN THE HOLE ON LEFT SIDE OF CAM INSERT ONLY (AS SHOWN).
- 14 APPLY PERMABOND LM113 OR LOCTITE 222 TO BAFFLE SCREW AFTER CALIBRATION.
- 15 USED WHEN PISTOL GRIP IS NOT INSTALLED.

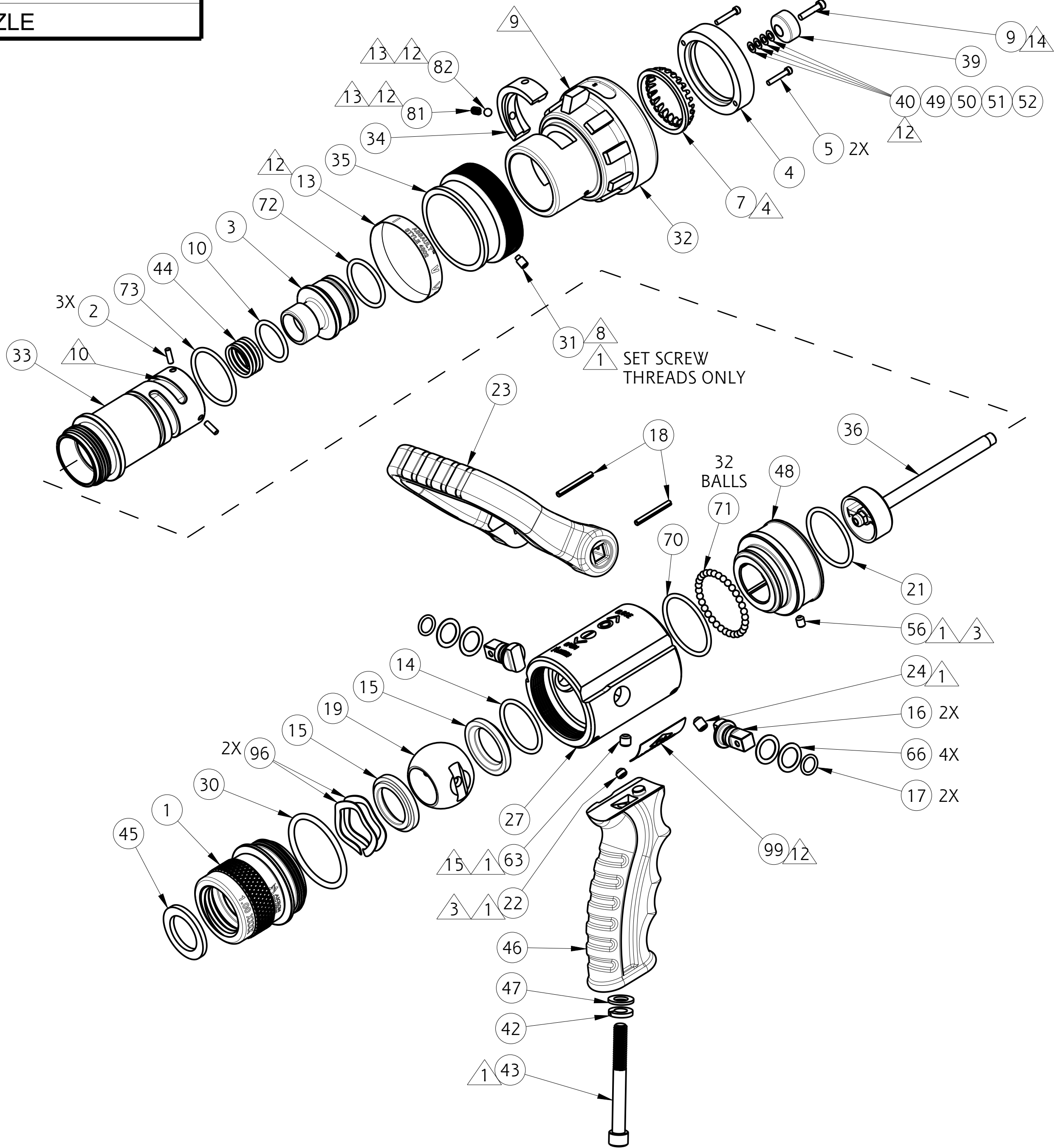

PHONE: 330.264.5678 or 800.228.1161 | FAX: 330.264.2944 or 800.531.7335 | www.akronbrass.com

Parts List Sheet:

127473

WARRANTY AND DISCLAIMER*: We warrant Akron Brass products for a period of five (5) years* after purchase against defects in materials or workmanship. Akron Brass will repair or replace product which fails to satisfy this warranty. Repair or replacement shall be at the discretion of Akron Brass. Products must be promptly returned to Akron Brass for warranty service. We will not be responsible for: wear and tear; any improper installation, use, maintenance or storage; negligence of the owner or user; repair or modification after delivery; failure to follow our instructions or recommendations; or anything else beyond our control. WE MAKE NO WARRANTIES, EXPRESS OR IMPLIED, OTHER THAN THOSE INCLUDED IN THIS WARRANTY STATEMENT, AND WE DISCLAIM ANY IMPLIED WARRANTY OF MERCHANTABILITY OR FITNESS FOR ANY PARTICULAR PURPOSE. Further, we will not be responsible for any consequential, incidental or indirect damages (including, but not limited to, any loss of profits) from any cause whatsoever. No person has authority to change this warranty. *Unless otherwise provided herein. Akron Brass industrial electronic components & the Severe-Duty Monitor have a one (1) year warranty. Select Akron Brass handline nozzles and valves carry a ten (10) year warranty. Scene Star Lights carry a (6) year warranty. Weldon products have a two (2) year warranty from date of manufacture (excluding consumable components). Select Weldon LED products carry a five (5) year warranty. Honda products have the manufacturers' warranty and Akron Brass disclaims any warranty in respect of those products.

© 2016 Akron Brass Company. All rights reserved. No portion of this can be reproduced without the express written consent of the Akron Brass Company.



TECHNICAL SERVICE PARTS

STYLE 4802

PRODUCT 1" ASSAULT NOZZLE

IF AN ITEM IS NOTED AS "NOT FIELD REPAIRABLE", OR YOU WISH TO RETURN AN ITEM TO AKRON BRASS FOR SERVICE PLEASE GO ONLINE TO, **ONLINEREPAIR.AKRONBRASS.COM**

Chg.	Date
03	06-19
04	03-20

FIND	DESCRIPTION	ITEM	QTY
1	SWIVEL S/A 1"NH	45104001	1
1	SWIVEL S/A 1"BSP	45104002	1
1	SWIVEL S/A 1"NPSH	45104003	1
2	PIN THROAT	745158	3
3	THROAT	127461	1
4	RETAINER TURBINE	756207	1
5	SCREW SOCKET HEAD CAP #4-40 x 5/8"	767094	2
7	A TURBINE TEETH	772024	1
9	SCREW SOCKET HEAD CAP #6-32 x 5/8"	765179	1
10	A O-RING 2-119	757330	1
13	BAND PATTERN INDICATOR YELLOW	803379	1
14	A O-RING 2-125	757281	1
15	A SEAT NOZZLE	769245	2
16	TRUNNION	127429	2
17	A O-RING 2-012	757282	2
18	A,D PIN ROLL 1/8" X 1-1/8"	744080	2
19	A BALL	704490	1
21	A O-RING 2-127	757048	1
22	SCREW SOCKET HEAD CUP POINT SET 1/4-20 x 1/4"	765002	1
23	D HANDLE SHUTOFF	721760	1
24	SCREW SOCKET HEAD CUP POINT SET NYLOCK 1/4-20 x 5/16"	766015	1
27	BODY SHUTOFF	127242	1
30	A O-RING 2-225	757375	1
31	SCREW SOCKET HEAD FULL DOG #10-24 x 5/16"	767088	1
32	SLEEVE PATTERN/BUMPER S/A	48024009	1
33	BODY NOZZLE	127460	1
34	INSERT CAM	723023	1
35	RING PATTERN SLEEVE	758338	1
36	STEM/SPIDER S/A	124381	1
39	HEAD BAFFLE 1" ETCH 50GPM@100PSI	127463	1
39	HEAD BAFFLE 1" ETCH 150LPM@7BAR	127464	1
39	HEAD BAFFLE 1" ETCH 50LPM@6BAR	127465	1
39	HEAD BAFFLE 1" ETCH 40GPM@100PSI	127466	1
39	HEAD BAFFLE 1" ETCH 25GPM@100PSI	127467	1
39	HEAD BAFFLE 1" ETCH 100LPM@7BAR	127468	1
39	HEAD BAFFLE 1" ETCH 13GPM@100PSI	127470	1
39	HEAD BAFFLE 1" ETCH 50LPM@7BAR	127471	1

FIND	DESCRIPTION	ITEM	QTY
42	C WASHER LOCK 5/16	784090	1
43	C SCREW SOCKET HEAD CAP 5/16-18 x 2-3/4"	765397	1
44	SPRING	769217	1
45	A,* GASKET	717047	1
46	C GRIP PISTOL	718330	1
47	C WASHER FLAT 5/16	784093	1
48	ADAPTER BASE	127459	1
49	** SHIM BAFFLE BLUE	769545	1
50	** SHIM BAFFLE BROWN	769546	1
51	** SHIM BAFFLE PINK	769547	1
52	** SHIM BAFFLE GREEN	769548	1
56	SCREW SOCKET HEAD CUP POINT SET #10-24 x 1/4"	765025	1
63	SCREW SOCKET HEAD CUP POINT SET 5/16-18 X 1/4"	765071	1
66	A CELCON SHIM	769351	4
70	A O-RING 2-128	757283	1
71	B BALL BRASS 5/32"DIA.	-	32
72	A O-RING 2-122	757331	1
73	A O-RING 2-125	757281	1
81	SPRING	768293	1
82	BALL STAINLESS STEEL 5/32 DIA.	704585	1
96	SPRING SMALLEY	768272	2
99	LABEL FM	729669	1
A	FIELD SERVICE KIT (2000 - PRESENT)	91800001	
B	KIT OF 50 BALLS, 5/32 BRASS	109042	
C	KIT SERVICE PISTOL GRIP WITH COLOR CLIPS	90040001	
D	KIT SERVICE 1.5" SHUTOFF HANDLE WITH COLOR CLIPS	90060001	
E	KIT SERVICE COLOR CLIPS ONLY FOR SHUTOFF HANDLES AND PISTOL GRIPS	90070001	

* INCLUDED IN SWIVEL S/A ITEM 1
 ** INSTALLED AT FACTORY AS NEEDED FOR FINAL FLOW CALIBRATION.
 *** FOR OTHER AVAILABLE OPTIONS, INLET ADAPTERS AND KITS
 GO TO akronbrass.com - REFERENCE DOCUMENT 127762

PHONE: 330.264.5678 or 800.228.1161 | FAX: 330.264.2944 or 800.531.7335 | www.akronbrass.com

Parts List Sheet:

127473

WARRANTY AND DISCLAIMER: We warrant Akron Brass products for a period of five (5) years* after purchase against defects in materials or workmanship. Akron Brass will repair or replace product which fails to satisfy this warranty. Repair or replacement shall be at the discretion of Akron Brass. Products must be promptly returned to Akron Brass for warranty service. We will not be responsible for: wear and tear; any improper installation, use, maintenance or storage; negligence of the owner or user; repair or modification after delivery; failure to follow our instructions or recommendations; or anything else beyond our control. WE MAKE NO WARRANTIES, EXPRESS OR IMPLIED, OTHER THAN THOSE INCLUDED IN THIS WARRANTY STATEMENT, AND WE DISCLAIM ANY IMPLIED WARRANTY OF MERCHANTABILITY OR FITNESS FOR ANY PARTICULAR PURPOSE. Further, we will not be responsible for any consequential, incidental or indirect damages (including, but not limited to, any loss of profits) from any cause whatsoever. No person has authority to change this warranty. *Unless otherwise provided herein. Akron Brass industrial electronic components & the Severe-Duty Monitor have a one (1) year warranty. Select Akron Brass handline nozzles and valves carry a ten (10) year warranty. Scene Star Lights carry a (6) year warranty. Weldon products have a two (2) year warranty from date of manufacture (excluding consumable components). Select Weldon LED products carry a five (5) year warranty. Honda products have the manufacturers' warranty and Akron Brass disclaims any warranty in respect of those products.
 © 2016 Akron Brass Company. All rights reserved. No portion of this can be reproduced without the express written consent of the Akron Brass Company.